





### Guide Icon



### Product Ordering Code

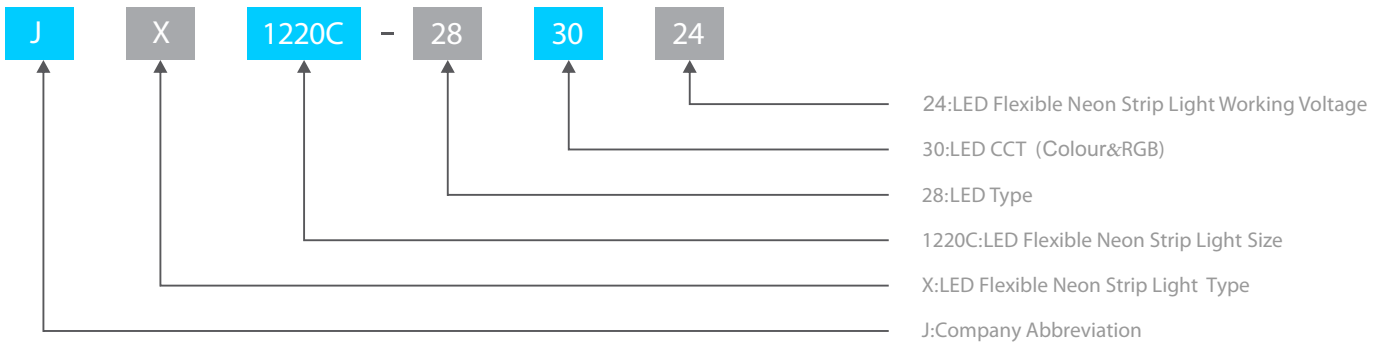

### Physical Specifications

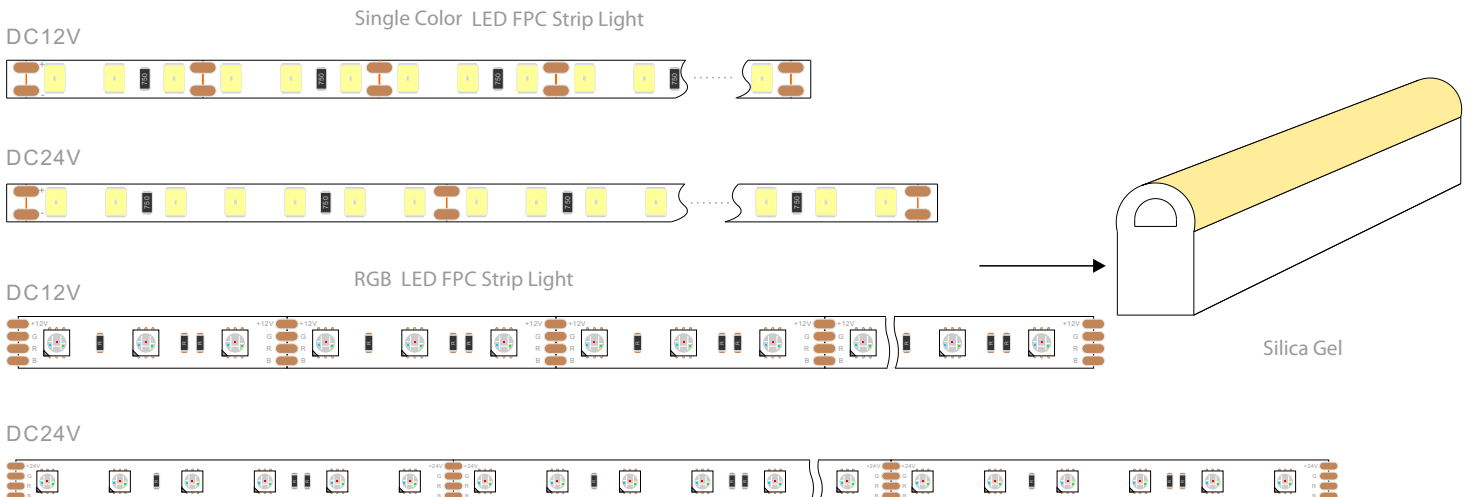

### Light Profile

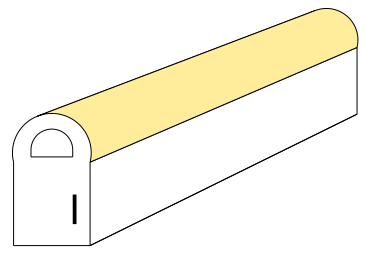

### Bending Direction

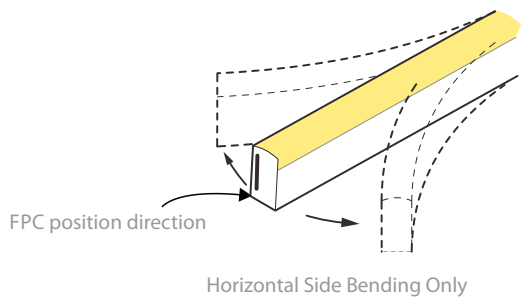
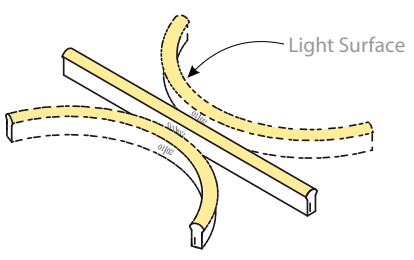
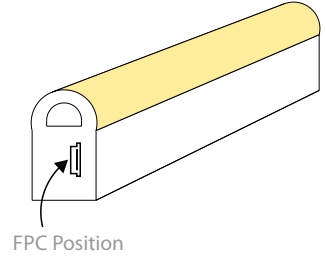
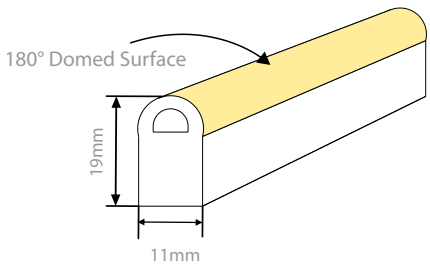

### Minimum Bending Diameter

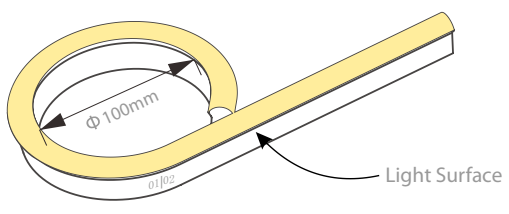



## Light distribution curve (Single Color)

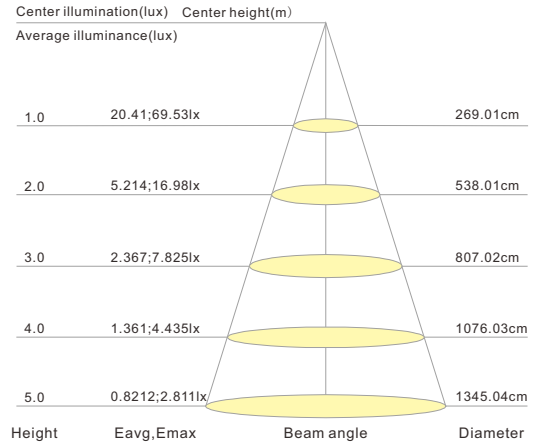
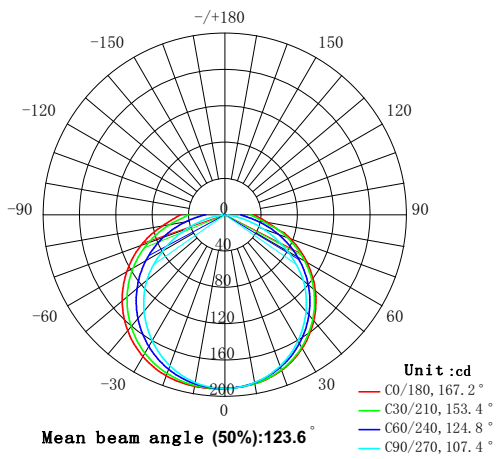

## Light distribution curve ( RGB )

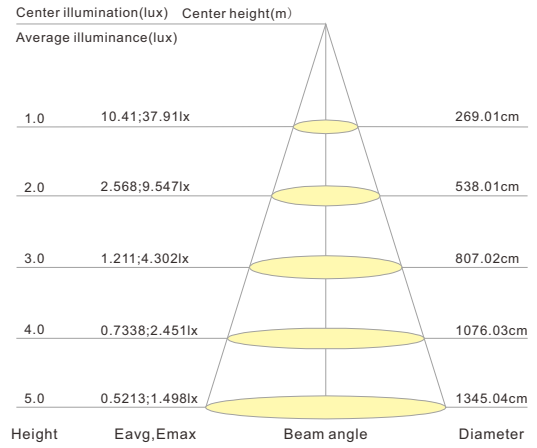
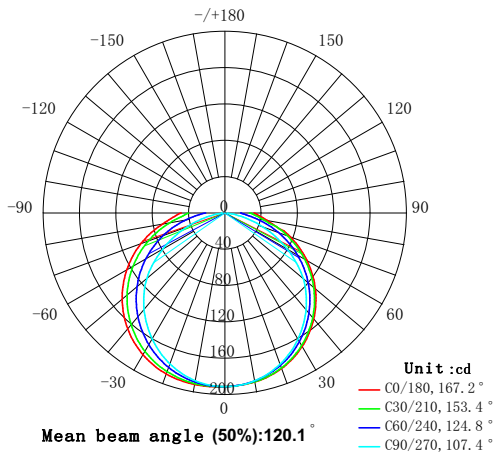

## LED Strip Light Loading Chart (Single Color)

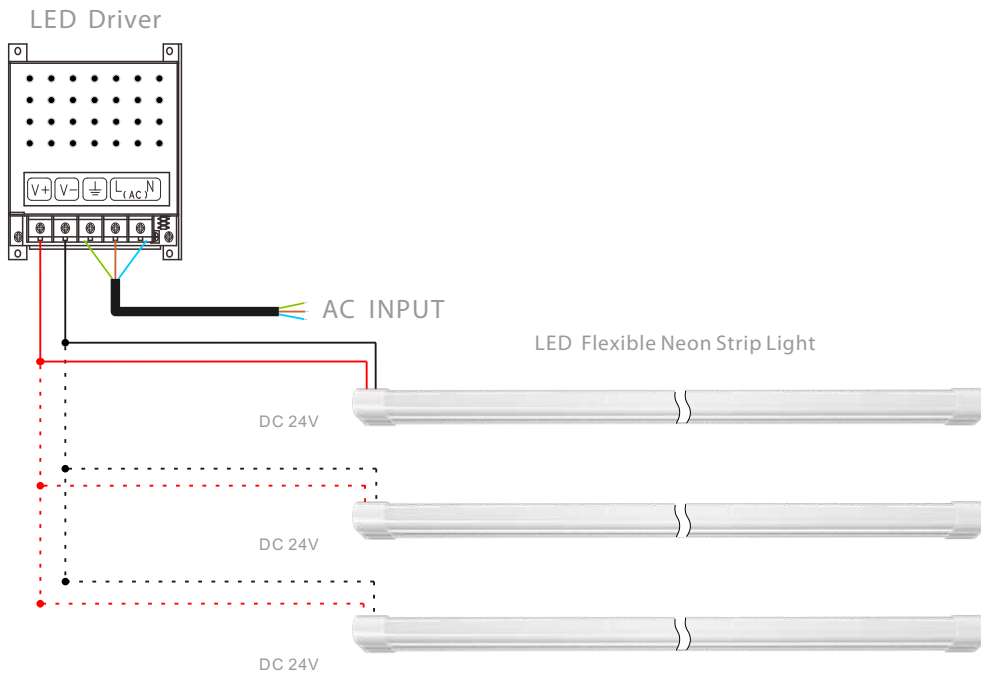

## LED Strip Light Loading Chart ( RGB )

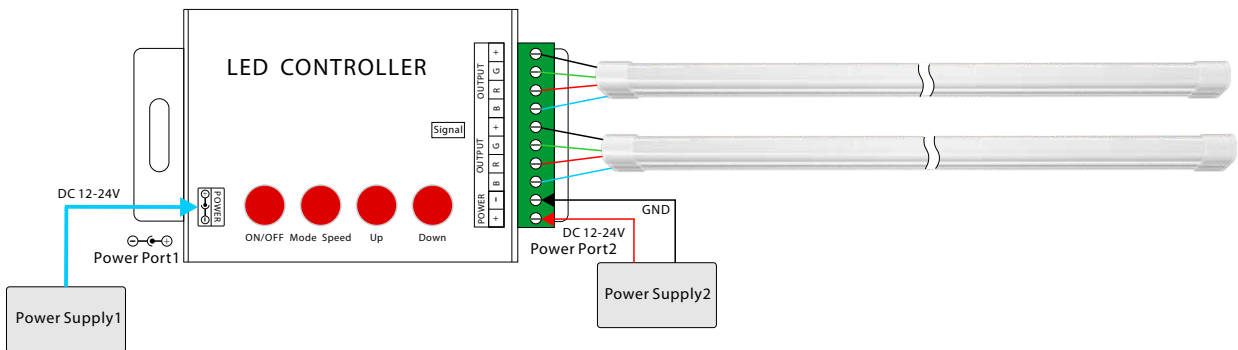

## Loading Chart



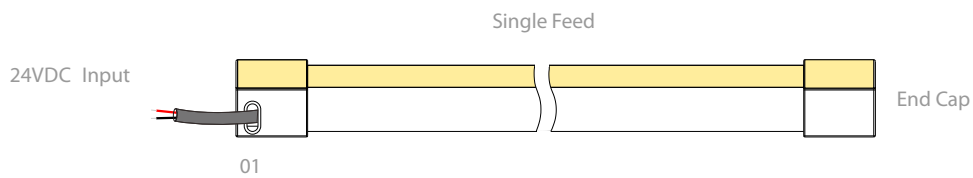

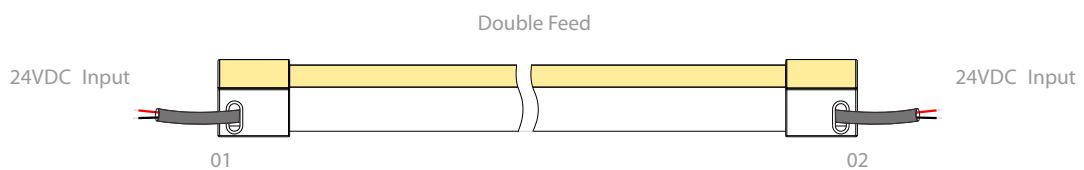

Rated Power	Power Supply
	66W
11W/m	5m

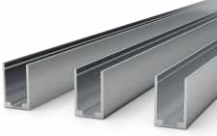

Rated Power	Power Supply
	140W
11W/m	10m



## Optional Accessory information

Image	Name	Descriptio	Size	Consumption
	Fixed clip	0.3mm stainless ,with screws	15*12.7*12mm	4PCS/1m
	Aluminium profile	Aluminium profile,flat mounting	1000*14.9*23.2mm	1PCS/1m
	End cap	Translucent, silica gel	21*13*13.5mm	2PCS
	End cap	Translucent, silica gel	21*13*27.5mm	One end/1PCS Dual ends/2PCS
	Double Insulated Electronic Wire	AWM 2464, 20AWG,0.5m <sup>2</sup>	L=200mm	One end/1PCS Dual ends/2PCS
	Single gray-and-white Wire	AWM, 22AWG,0.5m <sup>2</sup>	L=200mm	One end/1PCS Dual ends/2PCS
	Four rows of electronic wires (RGB)	AWM1007, 20AWG	L=200mm	One end/1PCS Dual ends/2PCS

## Packaging

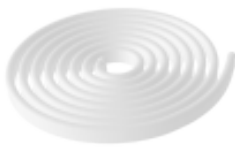

Packing Reel



Packing Electrostatic Bag



Packing Box

Fixture Length	Product quantity/carton	Carton N.W.	Carton G.W.	Carton size
5m	80m/1 carton	12.8kg	14.1kg	41x41x25cm